

TZN/TZ Series

Dual PID auto tuning control

■ Features

- Dual PID auto tuning function:
High-speed response of PID control to reach to the desired value fast, low-speed of response of PID control to minimize the overshoot even though response is a little bit slow.
- High display accuracy: $\pm 0.3\%$ (by F.S. value of each input)
- 2-Steps auto tuning control function
- Multi-input function
(13 kinds of multi-input selection function):
Temperature sensor, voltage and current selection function.
- Various sub output function:
Includes in LBA, SBA, 7kinds of alarm output and 4 kinds of alarm option function, PV transmission output(DC4-20mA), RS485 communication output
- Display the decimal point for analog input



⚠ Please read "Caution for your safety" in operation manual before using.



■ Ordering information

TZ 4 M - 1 4 R

| | | |
|------------------|--|--|
| Control output | R | Relay output |
| | S | SSR drive voltage output |
| Power supply*1 | C | Current output(DC4-20mA) |
| | 2 | 24VAC/24-48VDC |
| Auxiliary output | 4 | 100-240VAC 50/60Hz |
| | TZ4SP/TZN4S | |
| | 1 | Event 1 output |
| | TZ4ST | |
| | 1 | Event 1 output |
| | 2 | Event 1 + Event 2 output |
| | R | Event 1 + PV transmission output(DC4-20mA) |
| | Etc. | |
| | 1 | Event 1 output |
| | 2 | Event 1 + Event 2 output |
| | R | Event 1 + PV transmission output(DC4-20mA) |
| | A | Event 1 + Event 2 + PV transmission output(DC4-20mA) |
| | T | Event 1 + RS485 communication output |
| B | Event 1 + Event 2+RS485 communication output | |
| TZN4 | | |
| S | DIN W48×H48mm(terminal type) | |
| TZ4 | | |
| SP | DIN W48×H48mm(plug type) | |
| ST | DIN W48×H48mm(terminal type) | |
| TZ4/TZN4 | | |
| M | DIN W72×H72mm | |
| W | DIN W96×H48mm | |
| H | DIN W48×H96mm | |
| L | DIN W96×H96mm | |
| Digit | 4 | 9999(4 digit) |
| Item | TZ | Temperature dontroller(PID) |
| | TZN | Temperature dontroller (PID New type) |

*1: Only for TZ4SP, TZ4ST, TZ4L, TZN4M Series.

Dual PID Auto Tuning Control

■ Specifications

| Series | | TZ4SP TZN4S | TZ4ST | TZ4M TZN4M | TZ4W TZN4W | TZ4H TZN4H | TZ4L TZN4L |
|-------------------------|---------------------------|---|---------------------------|--|---|---|--------------------------------|
| Power supply | AC Power | 100-240VAC 50/60Hz | | | | | |
| | AC/DC Power ^{※1} | 24VAC 50/60Hz / 24-48VDC | | | | | |
| Allowable voltage range | | 90 to 110% of rated voltage | | | | | |
| Power consumption | AC Power | Max. 5VA(100-240VAC 50/60Hz) | | Max. 6VA(100-240VAC 50/60Hz) | | | |
| | AC/DC Power ^{※1} | Max. 8VA(24VAC 50/60Hz), Max. 7W(24-48VDC) | | | | | |
| Display accuracy | | 7 Segment (PV: red, SV: green) LED method | | | | | |
| Character size(W×H) | | TZ4SP: 4.8×7.8mm TZN4S: PV:7.8×11.0mm SV:5.8×8.0mm | 4.8×7.8mm | TZ4M: PV:9.8×14.2mm SV:8.0×10.0mm TZN4M: PV:8.0×13.0mm SV:5.0×9.0mm | 8.0×10.0mm | TZ4H: 3.8×7.6mm TZN4H: PV:7.8×11.0mm SV:5.8×8.0mm | PV:9.8×14.2mm SV:8.0×10.0mm |
| Input type | RTD | DPT100Ω, JPt100Ω, 3wire (allowable line resistance max. 5Ω per a wire) | | | | | |
| | Thermocouple | K(CA), J(IC), R(PR), E(CR), T(CC), S(PR), N(NN), W(TT) (allowable line resistance max. 100Ω) | | | | | |
| | Analogue | 1-5VDC, 0-10VDC, DC4-20mA | | | | | |
| Control output | Relay | 250VAC 3A 1c | | | | | |
| | SSR | 12VDC ±3V 30mA Max. | | | | | |
| | Current | DC4-20mA (load 600Ω Max.) | | | | | |
| Sub output | PV transmission | — | DC4-20mA (load 600Ω Max.) | | | | |
| | EVENT1 | 250VAC 1A 1a | | | | | |
| | EVENT2 | — | 250VAC 1A 1a | | | | |
| | Communication | — | — | RS485(PV/SV transmission, SV setting) | | | |
| Control type | | ON/OFF, P, PI, PD, PIDF, PIDS control | | | | | |
| Display accuracy | | F.S. ±0.3% or 3°C, select the higher one | | | | | |
| Setting method | | Front push buttons | | | | | |
| Hysteresis | | 1~100°C(0.1 to 100.0°C) variable(ON/OFF control) | | | | | |
| ALARM output | | Adjustable ON/OFF 1 to 100 (0.1 to 100.0)°C of alarm output | | | | | |
| Proportional band (P) | | 0.0 to 100.0% | | | | | |
| Integral time (I) | | 0 to 3600 sec. | | | | | |
| Derivative time (D) | | 0 to 3600 sec. | | | | | |
| Control period (T) | | 1 to 120 sec. | | | | | |
| Sampling period | | 0.5 sec. | | | | | |
| LBA setting | | 1 to 999 sec. | | | | | |
| RAMP setting | | Ramp Up, Ramp Down at 1 to 99min. | | | | | |
| Dielectric strength | | 2,000VAC 50/60Hz for 1min. (between power source terminal and input terminal) | | | | | |
| Vibration | | 0.75mm amplitude at frequency of 10 to 55Hz(for 1min.) in each of X, Y, Z direction for 2 hours | | | | | |
| Relay life cycle | Main output | Mechanical: Min. 10,000,000 operations, Electrical: Min. 100,000 operations(250VAC 3A resistive load) | | | | | |
| | Sub output | Mechanical: Min. 20,000,000 operations, Electrical: Min. 500,000 operations(250VAC 1A resistive load) | | | | | |
| Insulation resistance | | Min. 100MΩ (at 500VDC megger) | | | | | |
| Noise resistance | | ±2kV the square wave noise (pulse width: 1us) by the noise simulator | | | | | |
| Memory retention | | Approx. 10 years (when using non-volatile semiconductor memory type) | | | | | |
| Environment | Ambient temperature | -10 to 50°C, storage: -20 to 60°C | | | | | |
| | Ambient humidity | 35 to 85%RH, storage: 35 to 85%RH | | | | | |
| Approval | | CE c RU _{us} | | | | | |
| Unit weight | | TZ4SP: Approx. 136g TZN4S: Approx. 150g | Approx. 136g | Approx. 270g | TZ4W: Approx. 270g TZN4W: Approx. 259g | Approx. 259g | Approx. 360g |

※1. AC/DC power type is only for TZ4SP, TZ4ST, TZN4M, TZ4L Series.

※Environment resistance is rated at no freezing or condensation.

| | |
|-----|----------------------------------|
| (A) | Photo electric sensor |
| (B) | Fiber optic sensor |
| (C) | Door/Area sensor |
| (D) | Proximity sensor |
| (E) | Pressure sensor |
| (F) | Rotary encoder |
| (G) | Connector/Socket |
| (H) | Temp. controller |
| (I) | SSR/ Power controller |
| (J) | Counter |
| (K) | Timer |
| (L) | Panel meter |
| (M) | Tacho/ Speed/ Pulse meter |
| (N) | Display unit |
| (O) | Sensor controller |
| (P) | Switching mode power supply |
| (Q) | Stepper motor& Driver&Controller |
| (R) | Graphic/ Logic panel |
| (S) | Field network device |
| (T) | Software |
| (U) | Other |

TZN/TZ Series

Connections

※RTD: DPT100Ω(3-wire type), JPT100Ω(3-wire type) ※T.C(Thermocouple): K, J, R, E, T, S, W, N
 ※In case of Analog input, please use T.C(Thermocouple) terminal and be careful about polarity.

TZN4S

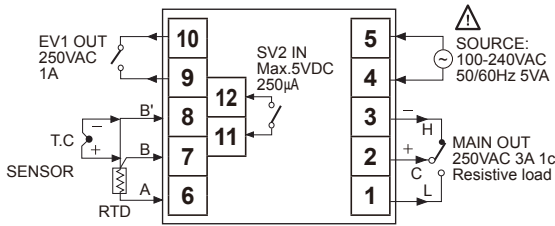

| MAIN OUT | |
|--------------------------------|------------------------------------|
| SSR | Current |
| <p>12VDC ±3V 30mA Max.</p> | <p>DC4-20mA Load 600Ω Max.</p> |

TZN4M

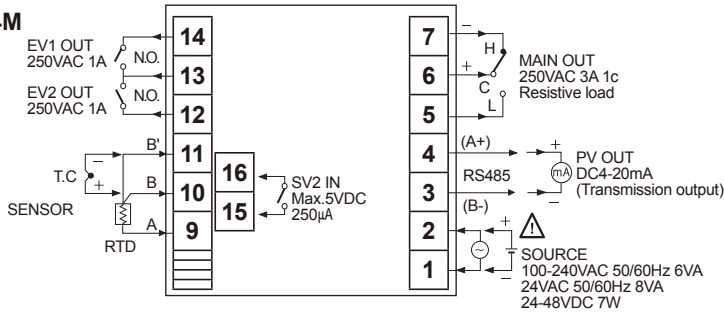

| MAIN OUT | |
|--------------------------------|------------------------------------|
| SSR | Current |
| <p>12VDC ±3V 30mA Max.</p> | <p>DC4-20mA Load 600Ω Max.</p> |

TZ4SP

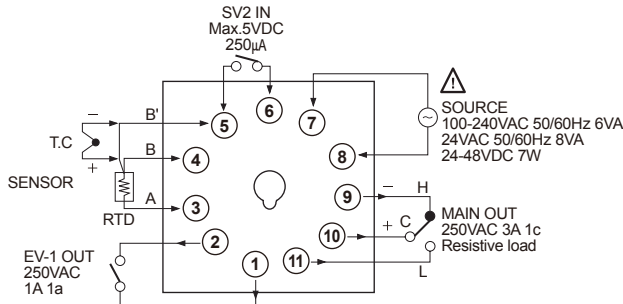

| MAIN OUT | |
|--------------------------------|------------------------------------|
| SSR | Current |
| <p>12VDC ±3V 30mA Max.</p> | <p>DC4-20mA Load 600Ω Max.</p> |

TZ4ST

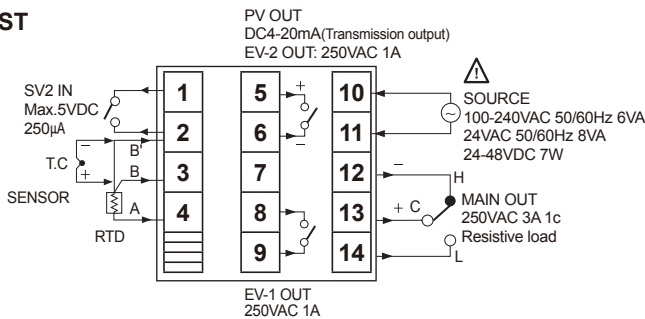

| MAIN OUT | | SUB OUT |
|--------------------------------|------------------------------------|------------------------------------|
| SSR | Current | PV transmission output |
| <p>12VDC ±3V 30mA Max.</p> | <p>DC4-20mA Load 600Ω Max.</p> | <p>DC4-20mA Load 600Ω Max.</p> |

TZ4M

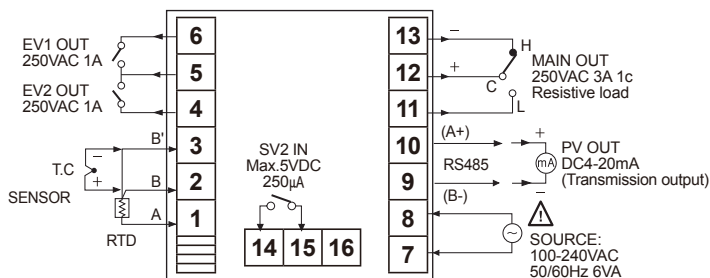

| MAIN OUT | |
|--------------------------------|------------------------------------|
| SSR | Current |
| <p>12VDC ±3V 30mA Max.</p> | <p>DC4-20mA Load 600Ω Max.</p> |

Dual PID Auto Tuning Control

● TZ4W/TZN4W

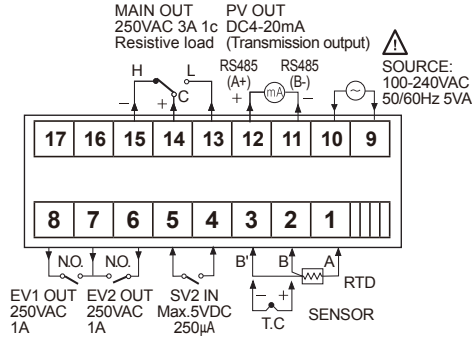

| MAIN OUT | |
|------------------------|----------------------------|
| SSR | Current |
| | |
| 12VDC ±3V 30mA Max. | DC4-20mA Load 600Ω Max. |

● TZ4H / TZN4H

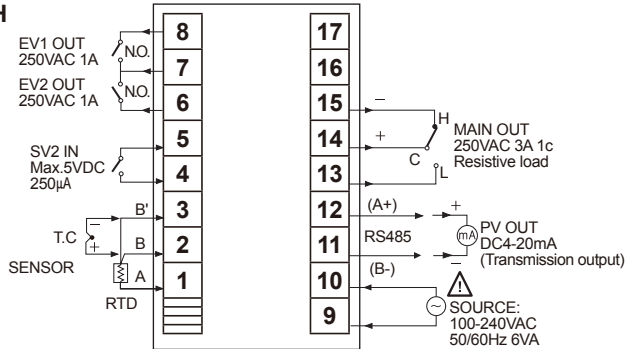

| MAIN OUT | |
|------------------------|----------------------------|
| SSR | Current |
| | |
| 12VDC ±3V 30mA Max. | DC4-20mA Load 600Ω Max. |

● TZ4L / TZN4L

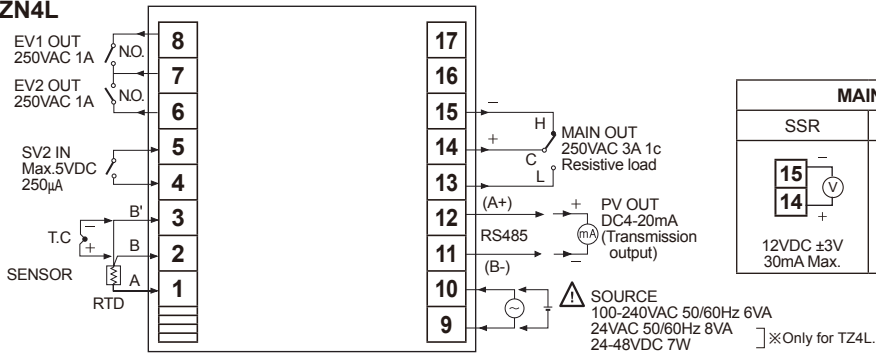

| MAIN OUT | |
|------------------------|----------------------------|
| SSR | Current |
| | |
| 12VDC ±3V 30mA Max. | DC4-20mA Load 600Ω Max. |

■ Dimensions

(unit: mm)

● TZN4S

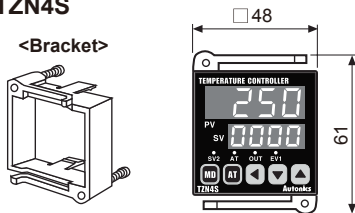

● Panel cut-out

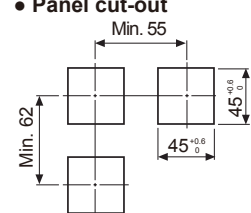

● TZN4M

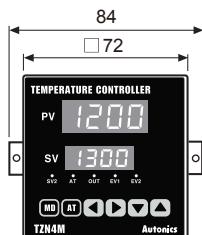

● Panel cut-out

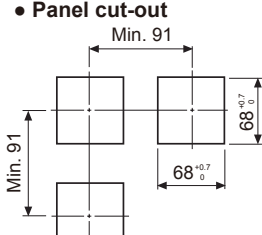

(A) Photo electric sensor

(B) Fiber optic sensor

(C) Door/Area sensor

(D) Proximity sensor

(E) Pressure sensor

(F) Rotary encoder

(G) Connector/Socket

(H) Temp. controller

(I) SSR/Power controller

(J) Counter

(K) Timer

(L) Panel meter

(M) Tacho/Speed/Pulse meter

(N) Display unit

(O) Sensor controller

(P) Switching mode power supply

(Q) Stepper motor& Driver&Controller

(R) Graphic/Logic panel

(S) Field network device

(T) Software

(U) Other

TZN/TZ Series

■ Dimensions

(unit: mm)

● TZ4SP

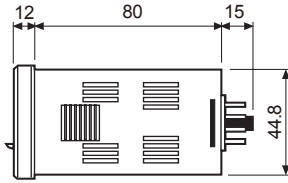
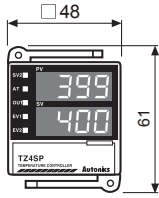

● Panel cut-out

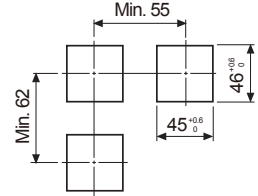

● TZ4ST

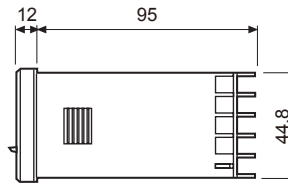
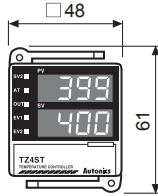

<Bracket>

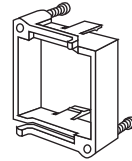

※Since TZ4SP uses same identification plate with TZ4ST, the lamp does not work even though it has a EV2 output signal lamp.

● TZ4M

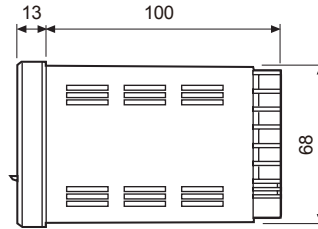
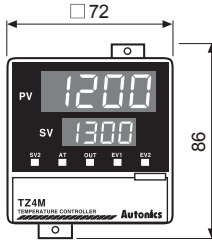

● Panel cut-out

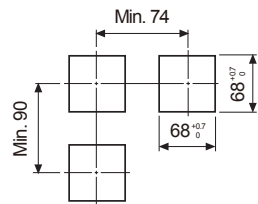

● TZ4W

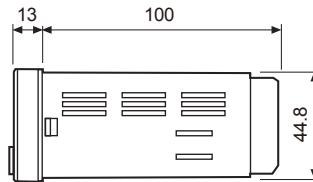
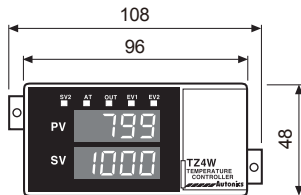

● Panel cut-out

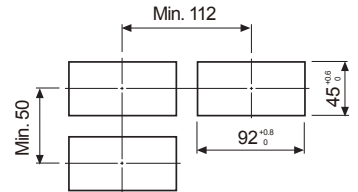

● TZN4W

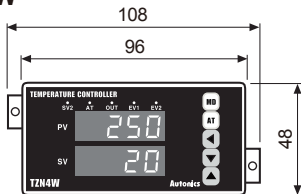

● TZ4H

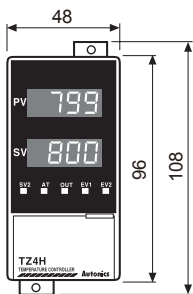

● TZN4H

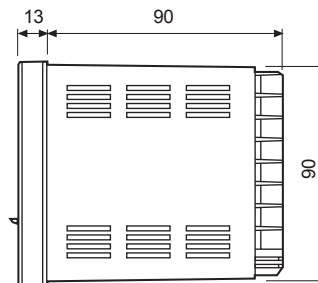
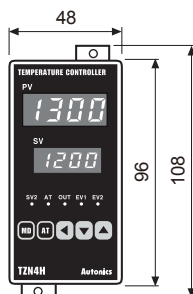

● Panel cut-out

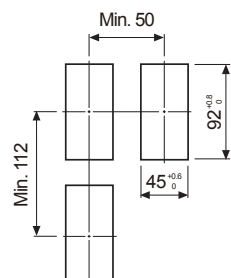

Dual PID Auto Tuning Control

● TZ4L

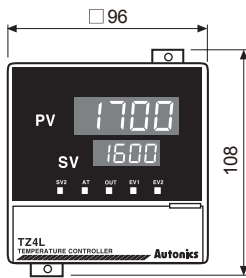

● TZN4L

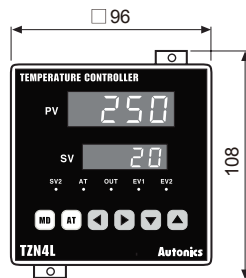

● Panel cut-out

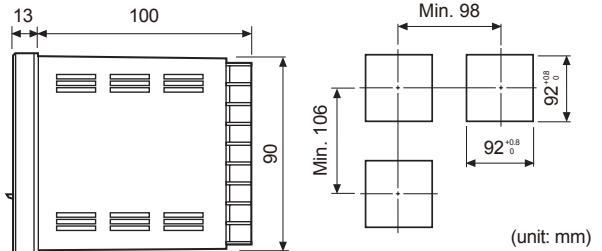

(unit: mm)

■ Parts description

● TZN4S

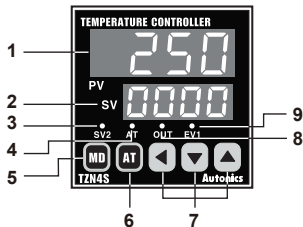

● TZN4M

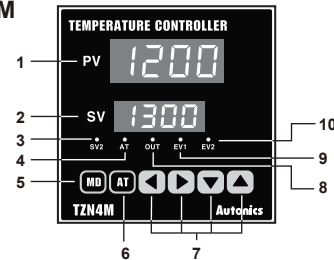

● TZ4ST/TZ4SP

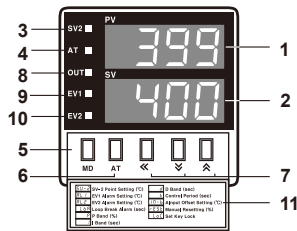

● TZ4M

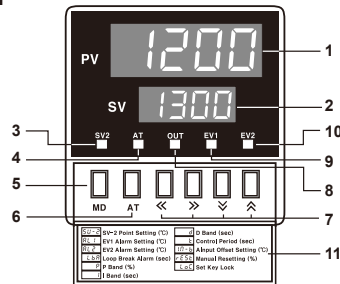

- 1: Display Processing value(PV) (Red)
- 2: Display Setting value(SV) (Green)
- 3: Indicate SV2 operation
- 4: Indicate Auto-tuning operation
- 5: Mode key
- 6: Autotuning operation key
- 7: Setting keys
- 8: Indicate control output operation
- 9: Indicate EVENT 1 output
- 10: Indicate EVENT 2 output
- 11: Procedure of setting key

※ Since TZ4SP uses same identification plate with TZ4ST, the lamp does not work even though it has a EV2 output signal lamp.
 ※ There are no (▶, ◀) Key in TZ4SP/TZ4ST/TZ4H/TZ4W and TZN4S/TZN4H/TZN4W.
 ※ Control output indicator(OUT) does not work when it is used as current output type.

■ SV setting

1 Press any key among (◀, ▶) key in RUN mode, the right digit at SV display flashes and it enters to SV setting.

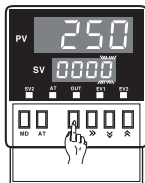

2 Press (◀) key to move the desired digit.
 ($10^0 \rightarrow 10^1 \rightarrow 10^2 \rightarrow 10^3 \rightarrow 10^0$)

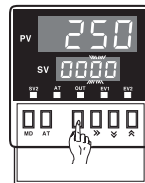

3 Press (▲, ▼) key to move the desired number (1 → 5).

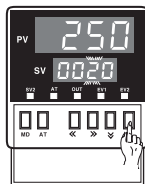

4 Press (MD) key to save the value and it controls with this set value.

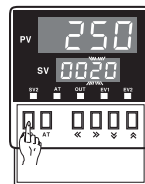

※ Above explanations are the example of TZ4M. In case of TZ Series. Use the Key in brackets for setting(changing).
 There are no (▶, ◀) Key in TZN4S, TZ4SP and TZ4ST. It is not used for setting or changing the setting value.

| | |
|-----|----------------------------------|
| (A) | Photo electric sensor |
| (B) | Fiber optic sensor |
| (C) | Door/Area sensor |
| (D) | Proximity sensor |
| (E) | Pressure sensor |
| (F) | Rotary encoder |
| (G) | Connector/Socket |
| (H) | Temp. controller |
| (I) | SSR/ Power controller |
| (J) | Counter |
| (K) | Timer |
| (L) | Panel meter |
| (M) | Tacho/ Speed/ Pulse meter |
| (N) | Display unit |
| (O) | Sensor controller |
| (P) | Switching mode power supply |
| (Q) | Stepper motor& Driver&Controller |
| (R) | Graphic/ Logic panel |
| (S) | Field network device |
| (T) | Software |
| (U) | Other |

TZN/TZ Series

Flow chart for parameter 1 group

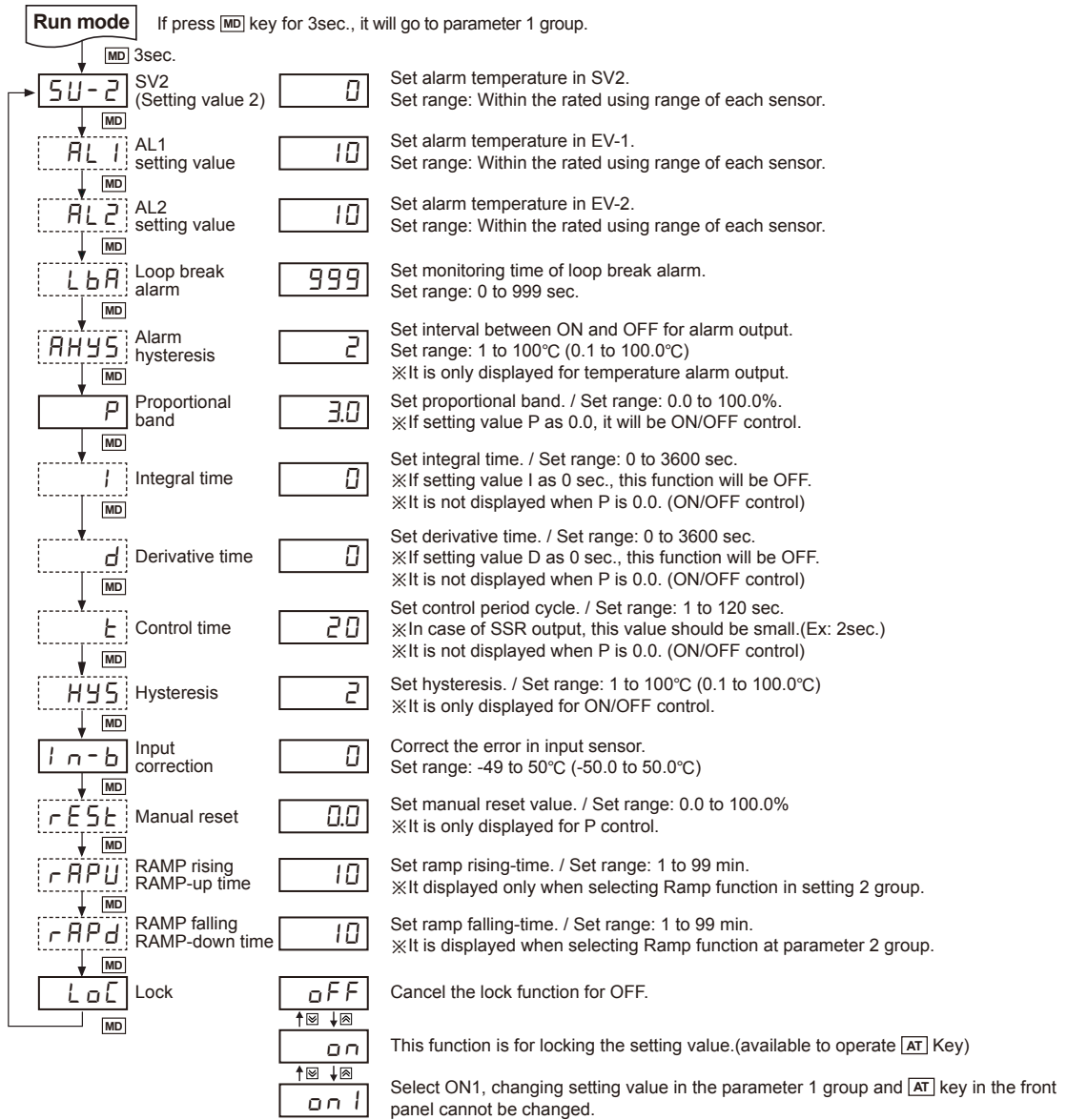

※Press **[←]** (**⏪**) key and the right digit of SV display part flashes. Press **[←]** (**⏪**) or **[→]** (**⏩**) key and move to the desired digit.

Press **[↑]** (**⏶**), **[↓]** (**⏷**) keys to change SV and press **[MD]** key to complete the set. Press **[MD]** key again and it moves to next parameter.

※After completing setting at each parameter, press **[MD]** key for 3 sec. and it returns to RUN mode.

※If no key touched for 60sec., it will return to RUN mode automatically.

※[] This parameter [AL1, AL2, LbA, I, d, t, HYS, rEst, rAPU, rAPd] might not be displayed depending on other parameter settings.

Factory defaults(Parameter 1 group)

| Parameter | Factory default | Parameter | Factory default | Parameter | Factory default | Parameter | Factory default |
|-----------|-----------------|-----------|-----------------|-----------|-----------------|-----------|-----------------|
| SU-2 | 0 | AHYS | 2 | t | 20 | rAPU | 10 |
| AL1 | 10 | P | 3.0 | HYS | 2 | rAPd | 10 |
| AL2 | 10 | I | 0 | In-b | 0 | LoC | oFF |
| LbA | 600 | d | 0 | rEst | 0.0 | | |

Dual PID Auto Tuning Control

Parameter 2 group

Run mode If pressing **[MD]** + **[↔]** key for 3sec. at once in RUN state, it will go to parameter 2 group.

Navigation flowchart showing parameter screens and their values:

- Input type:** In-t
- Event 1 mode:** EU-1
- Event 2 mode:** EU-2
- Alarm type:** AL-t
- Auto-tuning type:** AL-t
- PID type:** PIDt
- Control operating type:** o-ft
- Temperature unit:** Unit
- Scaling high limit:** H-SC
- Scaling low limit:** L-SC
- Decimal point:** dot
- Lock:** LoC
- Communication address:** AdrS
- Communication speed:** bPS
- Ramp function:** rAnP
- Transmission output low limit:** FS-L
- Transmission output high limit:** FS-H

Parameter list (marked with *1):

- PCRH, LbA, LbA, AL-A, tun1, PID5, HEAt, °C, 1300, -100, dot
- PCAL, SBA, SBA, AL-b, tun2, PIDF, COOL, °F, 0.0
- U1CH, AL-0, AL-0, AL-C
- U1CL, AL-1, AL-1, AL-d
- rPr, AL-2, AL-2
- ECrH, AL-3, AL-3
- ECrL, AL-4, AL-4
- ECCrH, AL-5, AL-5
- ECCrL, AL-6, AL-6
- SPr
- Ann
- Ute
- JPEH
- JPEL
- dPEH
- dPEL
- A--1
- A--2
- A--3

| | | | |
|------|--|------|--|
| In-t | Input type: Select from 19 type | L-SC | Set scaling low limit (include analog output) |
| EU-1 | Event 1: Select from 9 type | dot | Select decimal point position for Analog input |
| EU-2 | Event 2: Select from 9 type | FS-H | Set the high-limit when retransmission output is applied. (20mA) |
| AL-t | Alarm type: Select from 4 type | FS-L | Set the low-limit when retransmission output is applied. (4mA) |
| AL-t | Auto-tuning: Selectable tun1 or tun2. | rAnP | Able to set ON and OFF of Ramp function. |
| PIDt | PID: Selectable PIDF or PID5. | bPS | Set communication speed |
| o-ft | Selectable heat-function or cool-function | AdrS | Set communication address(01 to 99) |
| Unit | Temperature unit: °C or °F | LoC | The data cannot be changed when the lock key is ON |
| H-SC | Set scaling high limit (include analog output) | | |

- ※ Press **[←]** (**⏪**) key and the right digit of SV display part flashes. Press **[←]** (**⏪**) or **[→]** (**⏩**) key and move to the desired digit.
- Press **[↑]** (**⏴**), **[↓]** (**⏵**) keys to change SV and press **[MD]** key to complete the set. Press **[MD]** key again and it moves to next parameter.
- ※ After completing setting at each parameter, press **[MD]** key for 3 sec. and it returns to RUN mode.
- ※ If no key touched for 60sec., it will return to RUN mode automatically.
- ※1: It may not be displayed by input type switch.
- ※2: This is displayed only for model with High/Low-limit of transmission output.

Factory defaults(Parameter 2 group)

| Parameter | Factory default | Parameter | Factory default | Parameter | Factory default | Parameter | Factory default |
|-----------|-----------------|-----------|-----------------|-----------|-----------------|-----------|-----------------|
| In-t | PCRH | AL-t | AL-A | PIDt | PID5 | H-SC | 1300 |
| EU-1 | AL-1 | AL-t | tun1 | o-ft | HEAt | L-SC | -100 |
| EU-2 | AL-2 | rAnP | oFF | Unit | °C | LoC | oFF |







- (A) Photo electric sensor
- (B) Fiber optic sensor
- (C) Door/Area sensor
- (D) Proximity sensor
- (E) Pressure sensor
- (F) Rotary encoder
- (G) Connector/Socket
- (H) Temp. controller
- (I) SSR/ Power controller
- (J) Counter
- (K) Timer
- (L) Panel meter
- (M) Tacho/ Speed/ Pulse meter
- (N) Display unit
- (O) Sensor controller
- (P) Switching mode power supply
- (Q) Stepper motor& Driver&Controller
- (R) Graphic/ Logic panel
- (S) Field network device
- (T) Software
- (U) Other

TZN/TZ Series

Input type and range

| Input type | | Display | Input range(°C) | Input range(°F) |
|--------------|-----------|---|-------------------|--------------------------------|
| Thermocouple | K(CA) H | $\mathcal{K} \mathcal{C} \mathcal{R} \mathcal{H}$ | -100 to 1300°C | -148 to 2372°F |
| | K(CA) L | $\mathcal{K} \mathcal{C} \mathcal{R} \mathcal{L}$ | -100.0 to 999.9°C | This mode cannot be used as °F |
| | J(IC) H | $\mathcal{J} \mathcal{I} \mathcal{C} \mathcal{H}$ | 0 to 800°C | 32 to 1472°F |
| | J(IC) L | $\mathcal{J} \mathcal{I} \mathcal{C} \mathcal{L}$ | 0.0 to 800.0°C | This mode cannot be used as °F |
| | R(PR) | $\mathcal{r} \mathcal{P} \mathcal{r}$ | 0 to 1700°C | 32 to 3092°F |
| | E(CR) H | $\mathcal{E} \mathcal{C} \mathcal{r} \mathcal{H}$ | 0 to 800°C | 32 to 1472°F |
| | E(CR) L | $\mathcal{E} \mathcal{C} \mathcal{r} \mathcal{L}$ | 0.0~800.0°C | This mode cannot be used as °F |
| | T(CC) H | $\mathcal{T} \mathcal{C} \mathcal{C} \mathcal{H}$ | -200 to 400°C | -328 to 752°F |
| | T(CC) L | $\mathcal{T} \mathcal{C} \mathcal{C} \mathcal{L}$ | -199.9 to 400.0°C | This mode cannot be used as °F |
| | S(PR) | $\mathcal{S} \mathcal{P} \mathcal{r}$ | 0 to 1700°C | 32 to 3092°F |
| | N(NN) | $\mathcal{n} \mathcal{n} \mathcal{n}$ | 0 to 1300°C | 32 to 2372°F |
| | W(TT) | $\mathcal{W} \mathcal{T} \mathcal{T}$ | 0 to 2300°C | 32 to 4172°F |
| RTD | JPt100Ω H | $\mathcal{J} \mathcal{P} \mathcal{T} \mathcal{H}$ | 0 to 500°C | 32 to 932°F |
| | JPt100Ω L | $\mathcal{J} \mathcal{P} \mathcal{T} \mathcal{L}$ | -199.9 to 199.9°C | -199.9 to 391.8°F |
| | DPt100Ω H | $\mathcal{d} \mathcal{P} \mathcal{T} \mathcal{H}$ | 0 to 500°C | 32 to 932°F |
| | DPt100Ω L | $\mathcal{d} \mathcal{P} \mathcal{T} \mathcal{L}$ | -199.9 to 199.9°C | -199.9 to 391.8°F |
| Analog input | 0-10VDC | $\mathcal{A} - - \mathcal{1}$ | -1999 to 9999°C | -1999 to 9999°F |
| | 1-5VDC | $\mathcal{A} - - \mathcal{2}$ | -1999 to 9999°C | -1999 to 9999°F |
| | DC4-20mA | $\mathcal{A} - - \mathcal{3}$ | -1999 to 9999°C | -1999 to 9999°F |

Input type switch

| | | | | |
|--|---|---|------------|--|
| A) In case of sensor input : K(CA), J(IC), R(PR), E(CR), T(CC), S(PR), N(NN), W(TT), DPt 100Ω, JPt 100Ω | | | | |
| SW1 |  |  | SW2 | |
| SW1:1 | 1 1 | mA V | SW2: V | |
| B) In case of voltage input : 1-5VDC, 0-10VDC | | | | |
| SW1 |  |  | SW2 | |
| SW1:2 | 2 2 | mA V | SW2: V | |
| C) In case of current input : DC4-20mA | | | | |
| SW1 |  |  | SW2 | |
| SW1:2 | 2 2 | mA V | SW2: mA | |

※Factory default of input type switch: Temperature sensor input.

※Please select B) or C) according to input specification when it is voltage or current.

Dual PID Auto Tuning Control

Alarm

This unit has output for control and sub(alarm) output. Sub output is optional. (This alarm output is relay contact(1a) and operates regardless of output for control.) Alarm output operates when the temperature of target is getting higher or lower than setting value.

- Select one among 6 alarm operations [RL-1/2/3/4/5/6] of event 1, 2[EU-1, EU-2] at parameter 2 group and set alarm temperature (deviation or absolute temperature) in AL1, AL2 alarm temperature[RL1, RL2] at parameter 1 group.
- Since EU-1 and EU-2 operate separately, both EU-1 and EU-2 can be used as a high or low 2nd alarm operation.
- When selecting LbR or SbR function in EU-1, EU-2 of parameter 2 group, alarm cannot be operated.

Alarm operation

| Mode | Name | Alarm operation | Description |
|------|--|--|---|
| RL-0 | — | — | No alarm output |
| RL-1 | Deviation high-limit alarm | <p>High deviation: Set as 10°C High deviation: Set as -10°C</p> | If deviation between PV and SV as high-limit is higher than set value of deviation temperature, the alarm output will be ON. |
| RL-2 | Deviation low-limit alarm | <p>Lower deviation: Set as 10°C Lower deviation: Set as -10°C</p> | If deviation between PV and SV as low-limit is higher than set value of deviation temperature, the alarm output will be ON. |
| RL-3 | Deviation high/low-limit alarm | <p>Lower deviation: Set as 10°C, High deviation: Set as 20°C</p> | If deviation between PV and SV as high/low-limit is higher than set value of deviation temperature, the alarm output will be ON. |
| RL-4 | Deviation high/low-limit reserve alarm | <p>Lower deviation: Set as 10°C, High deviation: Set as 20°C</p> | If deviation between PV and SV as high/low-limit is higher than set value of deviation temperature, the alarm output will be OFF. |
| RL-5 | Absolute value high limit alarm | <p>Absolute-value Alarm: Set as 90°C Absolute-value Alarm: Set as 110°C</p> | If PV is higher than the absolute value, the output will be ON. |
| RL-6 | Absolute value low limit alarm | <p>Absolute-value Alarm: Set as 90°C Absolute-value Alarm: Set as 110°C</p> | If PV is lower than the absolute value, the output will be ON. |
| SbR□ | Sensor break Alarm | — | It will be ON when it detects sensor disconnection. |
| LbR□ | Loop break Alarm | — | It will be ON when it detects loop break. |

※ H: Alarm output hysteresis [RHYS]

Alarm option

| Mode | Name | Description |
|------|----------------------------------|---|
| RL-R | Standard alarm | If it is an alarm condition, alarm output is ON. If it is a clear alarm condition, alarm output is OFF. |
| RL-b | Alarm latch | If it is an alarm condition, alarm output is ON and maintains ON status. |
| RL-ζ | Standby sequence | First alarm condition is ignored and from second alarm condition, standard alarm operates. When power is supplied and it is an alarm condition, this first alarm condition is ignored and from the second alarm condition, standard alarm operates. |
| RL-d | Alarm latch and standby sequence | If it is an alarm condition, it operates both alarm latch and standby sequence. When power is supplied and it is an alarm condition, this first alarm condition is ignored and from the second alarm condition, alarm latch operates. |

| | |
|-----|----------------------------------|
| (A) | Photo electric sensor |
| (B) | Fiber optic sensor |
| (C) | Door/Area sensor |
| (D) | Proximity sensor |
| (E) | Pressure sensor |
| (F) | Rotary encoder |
| (G) | Connector/Socket |
| (H) | Temp. controller |
| (I) | SSR/Power controller |
| (J) | Counter |
| (K) | Timer |
| (L) | Panel meter |
| (M) | Tacho/Speed/Pulse meter |
| (N) | Display unit |
| (O) | Sensor controller |
| (P) | Switching mode power supply |
| (Q) | Stepper motor& Driver&Controller |
| (R) | Graphic/Logic panel |
| (S) | Field network device |
| (T) | Software |
| (U) | Other |

■ Functions

◎ Auto tuning [AT]

PID auto tuning function automatically measures the thermal characteristics and response of the control system and then executes its value under high response & stability after calculating the time constant of PID required to control optimum temperature.

- Execute the auto tuning function at initial time after connecting the controller & the sensor.
- Execution of auto tuning is started when pressing AT key for 3 sec. or more.
- When the auto tuning is started, AT lamp will flash, and when the lamp is OFF, this operation will stop.
- While the auto tuning function is executing, it is stopped by pressing AT key for 5sec. or more.
- When the power turns off or the stop signal is applied while auto tuning function is executing, time constant of PID is not changed and it remembers the value before power turns off.
- Time constant of PID selected by auto tuning function can be changed in parameter 1 group.
- It has two kinds of auto tuning mode auto tuning operation is executed at setting value(SV) in $tun1$ mode which is factory default. Auto tuning operation in $tun2$ mode is executed in 70% of setting value(SV). Mode change is available in AT of the parameter 2 group.

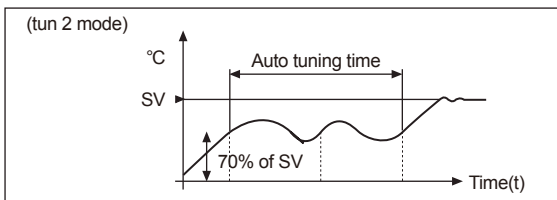
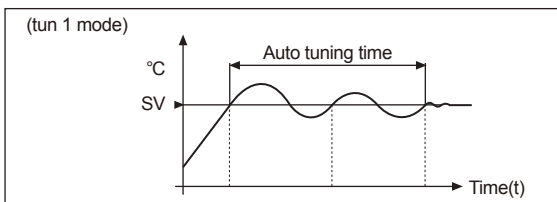

- Execute the auto tuning function again periodically, because the thermal characteristics for the control object can be changed when the controller is used continuously for a long time.

◎ Sub output [$EU-1, EU-2$]

Sub output can execute as main control output and sub function as well. There is one sub output in this unit.

- This sub output is relay "1a" contact output.
- 1 mode can be selected among 7 kinds of alarm mode or LBA operated when the heater line is cut, SBA operated when the sensor line is cut.
- The Sub output can be latched ON or automatically reset depending on the alarm option mode selected.
- When the sensor line or the heater line is cut, SBA or LBA output turns on. This "Output on" status must be reset by turning the power off.

◎ Sensor Break Alarm [SbA]

This function causes the sub output to turn on when the sensor line is cut or open. It is easier to check that whether the sensor line is cut or not through buzzer or etc by exterior sub output (relay contact).

- For using SBA function, set SbA at $EU-1$ or $EU-2$ in parameter 2 group and SBA output operates as EV1 OUT or EV2 OUT contact.

◎ Loop Break Alarm [LbA]

LBA function is to diagnose an abnormal temperature of the control system. If the temperature of the control system is not changed within $\pm 2^{\circ}\text{C}$ during setting time of LBA, the LBA output will be ON.

Ex) When setting value(SV) is 300°C , process value(PV) is 50°C , this unit controls 100%. In this time if there is no change of system temperature, it recognizes Heater is cut off then LBA output will be ON.

- LBA output can be selected at EV1 of the parameter 2 group.
- If LbA output is not selected at event output, it will not be displayed in parameter 1 group.
- Set range of LBA: 1 to 999 sec.
- If thermal response of the control system is slow, LBA value should be set to a high value.
- LBA output operates when the manipulated value of the controller is 0% and 100%. In case the LBA output is ON, please check the following:
 - ① Short-circuit or cutting of the temp. sensor.
 - ② Abnormal condition of the equipment (magnet, sub-relay, etc.)
 - ③ Abnormal condition of the load(heater, cooler)
 - ④ Wrong-wiring or cutting of the other cables.
- Once SBA is ON due to broken sensor, it will not reset, although sensor is connected. In this case, turn off the power then turn on again.

◎ Error

If error is occurred while the controller is operating, it will be displayed as follow.

- $LLLL$ is flashing when measured input temperature is lower than input range of the sensor.
- $HHHH$ is flashing when measured input temperature is higher than input range of the sensor.
- $\sigma PE n$ is flashing when the input sensor is not connected or its wire is cut.

Dual PID Auto Tuning Control

◎ ON/OFF control

ON/OFF control is called two position control because the output turns on when PV falls lower than SV and the output turns off when PV is higher than SV.

This control method is not only for controlling temperature, but also it is basic control method for sequence control.

- If you set value P as 0.0 in parameter 1 group, ON/OFF control will operate.
- There is a programmable temperature difference between ON and OFF in ON/OFF control, if difference is too small, then hunting(chattering) can occur.
- Temperature difference can be set in HYS mode of parameter 1 group. Setting range is 1 to 100(or 0.1 to 100.0).
- HYS mode is displayed when P value is 0.0 , but HYS will not be displayed, and then jump if P value is not 0.0 .
- This ON/OFF control should not be applied when equipment(cooling compressor) to be controlled can be damaged by frequent ON and OFF.
- Even if ON/OFF control is stable status, the hunting can be occurred by setting value in HYS or capacity of the heater or response characteristic of the equipment to be controlled or installing position of the sensor. Please consider above points to minimize the hunting when designing the system.

◎ Manual reset [$rE5t$]

Proportional control has deviation because rising time is not same as falling time, even if the unit operates normally. Manual reset function is used at proportional control mode only.

- If set $rE5t$ function in parameter 1 group, the manual reset will run.
- When PV and SV is equal, $rE5t$ value is 50.0% and when control is stable, if the temperature is lower than SV, $rE5t$ value should be higher and on the other hand, $rE5t$ value should be smaller.
- $rE5t$ setting method according to result of control.

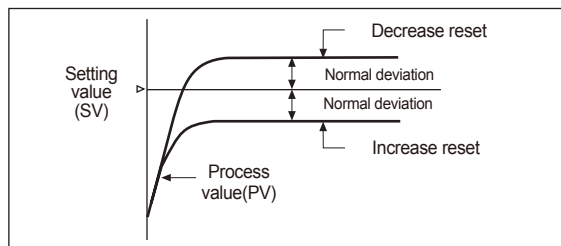

◎ Decimal point setting [dot]

Decimal point is displayed as dot in parameter 2 group when the input is analog only.(0-10VDC, 1-5VDC, DC4-20mA)

◎ Dual PID control

When controlling temperature, two types of control characteristic are available as below.

One is when you need to minimize the time which PV reaches to SV as like(Fig. 1). The other is when you need to minimize overshoot even though the reaching time(PV to SV) is slow(Fig. 2).

- There are high-speed response type and low-speed response type built in this unit. Therefore user can select each function according to their application.
- You can select dual PID control function in parameter 2 group. It is selectable $PI dF$ or $PI dS$ in $PI dE$ mode.
- $PI dF$ (high-speed response type)

This mode is applied to machines or systems which require high-speed response.

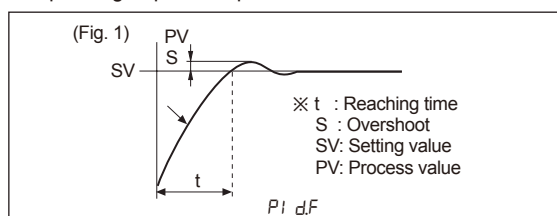

- $PI dS$ (low-speed response type)

It is PID Slow, used to minimize overshoot even though the response is slow. For control temperature of oil, plating machine have a possibility of fire with overshoot, $PI dS$ (limit over) should be used.

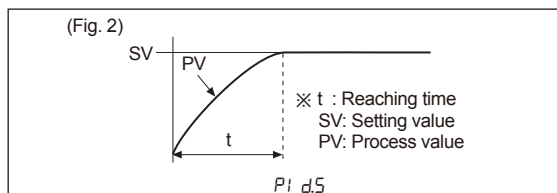

※Factory default setting is $PI dS$.

Please select mode according to control system.

◎ RS485 communication

It is used on the purpose that transmitting PV to an external equipment, setting SV at the external equipment.

- It can be set at $bP5$, $Rd5$ in second parameter 2 group.
- Communication speed[$bP5$] set range: 2400, 4800, 9600bps
- Start bit(1bit, fixed), Stop bit(1bit, fixed), Parity bit(none)
- Communication address[$Rd5$] set range: 1 to 99
- Communication converters (sold separately)
 - SCM-38I(RS-232C to RS485 converter)
 - SCM-US48I(USB to RS485 converter)
 - SCM-WF48(Wi-Fi to RS485/USB communication converter(available soon))

| | |
|-----|----------------------------------|
| (A) | Photo electric sensor |
| (B) | Fiber optic sensor |
| (C) | Door/Area sensor |
| (D) | Proximity sensor |
| (E) | Pressure sensor |
| (F) | Rotary encoder |
| (G) | Connector/Socket |
| (H) | Temp. controller |
| (I) | SSR/ Power controller |
| (J) | Counter |
| (K) | Timer |
| (L) | Panel meter |
| (M) | Tacho/ Speed/ Pulse meter |
| (N) | Display unit |
| (O) | Sensor controller |
| (P) | Switching mode power supply |
| (Q) | Stepper motor& Driver&Controller |
| (R) | Graphic/ Logic panel |
| (S) | Field network device |
| (T) | Software |
| (U) | Other |

◎ Cool / Heat function [σ -F ϵ]

Generally there are two ways to control temperature, one (heat-function) is to heat when PV is getting down(heater). The other(cool-function) is to cool when PV is getting higher (freezer).

These functions are operating oppositely when it is ON/OFF control or proportional control. But in this case PID time constant will be different due to PID time constant will be decided according to control system when it is PID control.

- Cool-function and heat-function can be set at Parameter 2 group.
- Cool-function [$C_{\sigma\sigma L}$] and heat-function [$H\epsilon R\epsilon$] must be set correctly according to the application, if set as opposite function, it may cause a fire. (If set cool-function [$C_{\sigma\sigma L}$] at heater, it will be maintained ON and it may cause a fire.)
- Avoid changing heat-function to cool-function or cool-function to heat-function when the unit is operating.
- It is impossible to operate both function at once in this unit. Therefore, only one function should be selected only.
- Factory default setting is heat-function [$H\epsilon R\epsilon$].

◎ SV2 function [5U-2]

If using SV2 function, it changes the temperature of control system to the second setting value by external relay contact signal.

It can change the setting value as sequentially by relay contact without key operation.

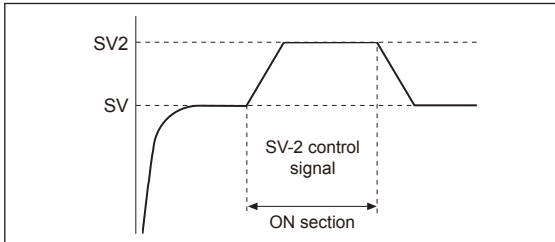

- It can set SV2 at required time and particular area as like the above chart.
- SV2 is in parameter 1 group.
- Application :
The control system, which has to maintain constant temperature such as oven. If you open the door, temperature will go down.

In this case, if you set the second setting value higher than setting value, temperature will rise fast. Therefore, after installing a micro-switch in order to detect the door Open/Close and connect it to SV2 (the second setting value should be higher than SV) then it controls temperature of oven efficiently.

◎ Ramp function [r AP \bar{n} P]

Ramp function is to delay the rising time or falling time of temperature. If you change setting value at stable state of control, it forces to rise or fall the temperature of control system during setting time at $rAP\bar{n}P$, $rAPd$ in parameter 1 group.

If $rAP\bar{n}P$ is not ON in parameter 2 group, $rAPU$, $rAPd$ will not be displayed in parameter 1 group.

- Set $rAP\bar{n}P$ is ON in parameter 2 group for using ramp function.
- Set the rising time and falling time at $rAPU$ mode and $rAPd$ mode of parameter 1 group.
- Ramp function will be operating when changing the set value at stable control status or supply the power again after the power was removed.
- The setting range of rising and falling time is 1 to 99 minute.

■ Ramp rising [$rAPU$] (delay of rising time)

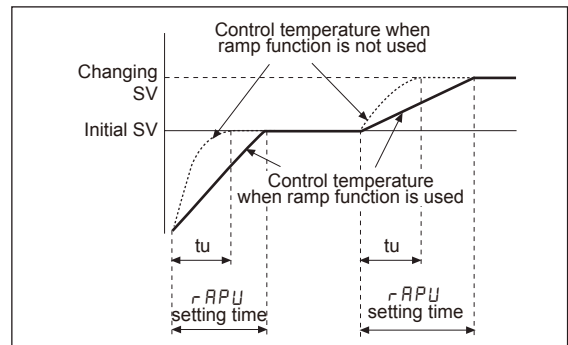

It makes delay rising temperature when change the set value at stable control status or delay the initial rising temperature as like above picture.

※ $rAPU$ time cannot be shorter than rising time(tu) of temperature when Ramp function is not used.

■ Ramp falling [$rAPd$] (delay of falling time)

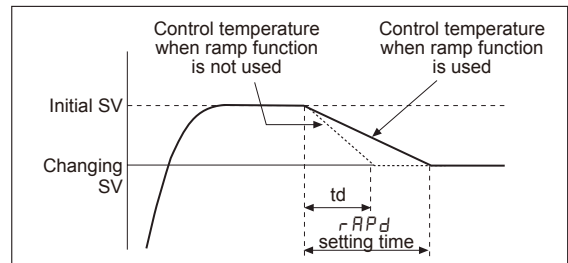

It controls falling temperature as like above.

※ $rAPd$ time cannot be shorter than falling time(td) of temperature when Ramp function is not used.

Dual PID Auto Tuning Control

◎ Input correction [I n - b]

Input correction is to correct deviation occurred from temperature sensor such as thermocouples, RTD, Analog sensor etc. If you check the deviation of every temperature sensor precisely, it can measure temperature accurately.

- Input revise can be set at I n - b mode in parameter 1 group.
- Use this mode after measuring deviation occurred from temperature sensor exactly. Because if measured deviation value is not corrected, displayed temperature may be too high or too low.
- Set range: -49 to 50°C(-50.0 to 50.0°C)
- When you set the Input revise value, you may need to record it, because it will be useful when performing maintenance.

◎ Analog input [A -- 1, A -- 2, A -- 3]

- In case of measuring or controlling humidity & pressure, flux, etc, it uses the proper converter which is converting the measuring value to DC4-20mA or 1-5VDC or 0-10VDC.

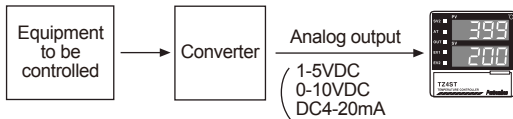

- To use analog output of converter as controller input, select the input type as same as analog output conditions. (This should be operated in power-off status.)
- This unit has the mode for the converter built-in.
- Please select A -- 1 (0-10VDC) or A -- 2 (1-5VDC) or A -- 3 (DC4-20mA) in selection mode of input in parameter 2 group.
- Set the input value by High scale [H - 5 C] and Low scale [L - 5 C] mode.
- Please connect the analog output of the converter to the temperature sensor terminal of the controller. Please be cautious of the polarity.
- After the procedure, it is controlled same with temperature control.
- Example of usage

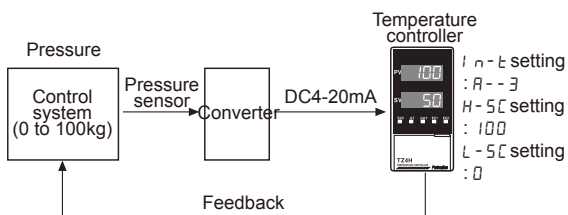

◎ Output connections

For more information about output, refer to the H-139 page.

● Application of relay output type

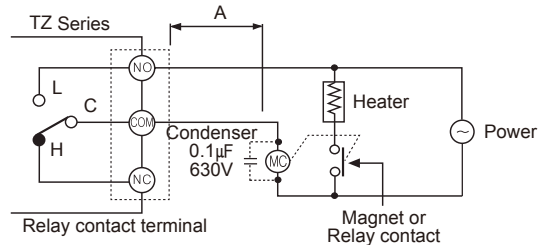

Keep power relay as far away as possible from TZ/TZN Series. If wires length of A is short, electromotive force occurred from a coil of magnet switch & power relay may flow in power line of the unit, it may cause malfunction. If wires length of A is short, please connect a mylar condenser 104(630V) across coil of the power relay "MC" to protect electromotive force.

● Application of SSR output type

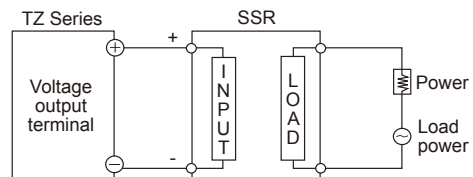

※SSR should be selected by the capacity of load, otherwise, it may short-circuit and result in a fire. Indirect heated should be used with SSR for efficient working.

※Please use a cooling plate or it may cause the capability deterioration, breakdown of SSR for a long usage.

● Application of current output(DC4-20mA)

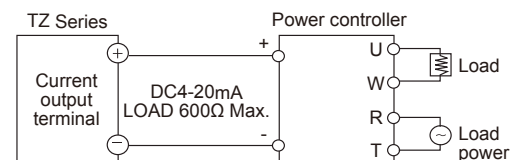

※It is important to select SCR unit after checking the capacity of the load.

※If the capacity is exceeded, it may cause a fire.

● Application of transmission output(DC4-20mA)

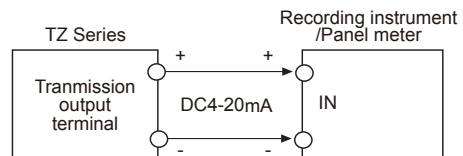

● Application of communication output(RS485)

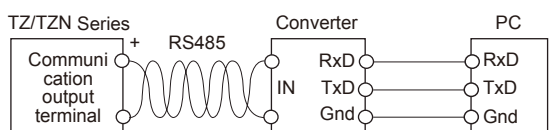

| | |
|-----|----------------------------------|
| (A) | Photo electric sensor |
| (B) | Fiber optic sensor |
| (C) | Door/Area sensor |
| (D) | Proximity sensor |
| (E) | Pressure sensor |
| (F) | Rotary encoder |
| (G) | Connector/Socket |
| (H) | Temp. controller |
| (I) | SSR/ Power controller |
| (J) | Counter |
| (K) | Timer |
| (L) | Panel meter |
| (M) | Tacho/ Speed/ Pulse meter |
| (N) | Display unit |
| (O) | Sensor controller |
| (P) | Switching mode power supply |
| (Q) | Stepper motor& Driver&Controller |
| (R) | Graphic/ Logic panel |
| (S) | Field network device |
| (T) | Software |
| (U) | Other |

TZN/TZ Series

■ Communication output

◎ Interface

| | |
|------------------------|---|
| Standard | EIA RS485 |
| Number of connections | Max. 31 units. It is available to set address 01 to 99. |
| Communication method | 2 wire half duplex |
| Synchronous method | Asynchronous type |
| Communication distance | Within 1.2km |
| Communication speed | 2400, 4800, 9600(available to set) |
| Start bit | 1bit(Fixed) |
| Stop bit | 1bit(Fixed) |
| Parity bit | None |
| Data bit | 8bit(Fixed) |
| Protocol | BCC |

◎ System ordering

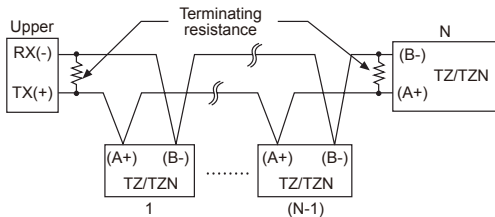

※Use a proper twist pair for communication.

◎ Communication control ordering

1. The communication control ordering of TZ/TZN Series is exclusive protocol.
2. After 4sec. being supplied the power into master system, then able to start communicating.
3. Initial communication will be started by master system. When Command signal comes out from master system then TZ/TZN Series will respond.

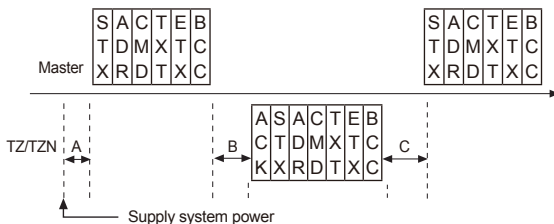

◎ Communication Command and Block

Format of Command and Response

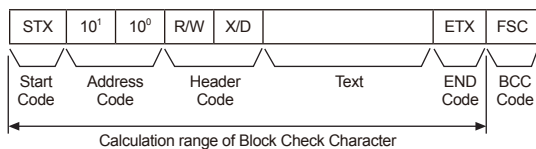

① Start code

It indicates the first of Block STX → [02H], in case of response, ACK will be added.

② Address code

This code is master system can discern TZ/TZN Series and able to set within range of 01 to 99.(BCD ASCII)

③ Header code:

It indicates command as 2 alphabets as below.

RX(Read request) → R[52H], X[58H]

RD(Read response) → R[52H], D[44H]

WX(Write request) → W[57H], R[58H]

WD(Write response) → W[57H], D[44H]

④ Text: It indicates the detail contents of Command/Response. (see command)

⑤ END code: It indicates the end of Block. ETX → [03H]

⑥ BCC: It indicates XOR operating value from the first to ETX of the protocol as abbreviation of TZ/TZN.

◎ Communication Command

● Read [RX] of measurement/setting value : Address 01, Command RX

1.Command (Master)

① Command

| | | | | | | | | |
|-------|---------|---|--------------|---|------------------------------------|-----|-----|-----|
| STX | 0 | 1 | R | X | P | 0 | ETX | FSC |
| Start | Address | | Command head | | P:Process value S:Setting value | End | BCC | |

② Application: Address(01), Header code(RX), Process value(P)

| | | | | | | | | |
|-----|----|----|----|----|----|----|-----|-----|
| STX | 0 | 1 | R | X | P | 0 | ETX | FSC |
| 02 | 30 | 31 | 52 | 58 | 50 | 30 | 03 | BCC |

● Write [WX] of setting value: Address 01, Command WX

1.Command(Master)

① Command

| | | | | | | | | | | | | | |
|-------|---------|--------------|---|-----------------|---|---------|-----------------|-----------------|-----------------|-----------------|-----------------|-----|-----|
| STX | 0 | 1 | W | X | S | 0 | Symbol | 10 ³ | 10 ² | 10 ¹ | 10 ⁰ | ETX | FSC |
| Start | Address | Command head | | S:Setting value | | Space/- | 10 ³ | 10 ² | 10 ¹ | 10 ⁰ | End | BCC | |

② Application: In case of writing Address(01), Heading Coad(WX), Setting value(S) +123.4.

| | | | | | | | | | | | | | |
|-----|----|----|----|----|----|----|--------|-----------------|-----------------|-----------------|-----------------|-----|-----|
| STX | 0 | 1 | W | X | S | 0 | Symbol | 10 ³ | 10 ² | 10 ¹ | 10 ⁰ | ETX | FSC |
| 02 | 30 | 31 | 57 | 58 | 53 | 30 | 20 | 30 | 31 | 32 | 33 | 03 | BCC |

◎ Response

● Read of process/Setting value

1. In case of receiving normal process value : The data is transmitted adding ACK[60H]. (In case process value is +123.4)

| | | | | | | | | | | | | | | | | |
|-------------|-------------|---|---|---|---|---|---|--------|-----------------|-----------------|-----------------|-----------------|---------------|-------------|-------------|------------------|
| A C K | S T X | 0 | 1 | R | D | P | 0 | Symbol | 10 ³ | 10 ² | 10 ¹ | 10 ⁰ | Decimal point | E T X | F S C | N U L L |
|-------------|-------------|---|---|---|---|---|---|--------|-----------------|-----------------|-----------------|-----------------|---------------|-------------|-------------|------------------|

| | | | | | | | | | | | | | | | | |
|-------------|-------------|---|---|---|---|---|---|-------|---|---|---|---|---|-------------|-------------|------------------|
| A C K | S T X | 0 | 1 | R | D | P | 0 | Space | 1 | 2 | 3 | 4 | 1 | E T X | B C C | N U L L |
|-------------|-------------|---|---|---|---|---|---|-------|---|---|---|---|---|-------------|-------------|------------------|

| | | | | | | | | | | | | | | | | |
|----|----|----|----|----|----|----|----|----|----|----|----|----|----|----|-------------|----|
| 06 | 02 | 30 | 31 | 52 | 44 | 50 | 30 | 20 | 31 | 32 | 33 | 34 | 31 | 03 | B C C | 00 |
|----|----|----|----|----|----|----|----|----|----|----|----|----|----|----|-------------|----|

2. In case process value is -100

| | | | | | | | | | | | | | | | | |
|-------------|-------------|---|---|---|---|---|---|---|---|---|---|---|---|-------------|-------------|------------------|
| A C K | S T X | 0 | 1 | R | D | P | 0 | - | 0 | 1 | 0 | 0 | 0 | E T X | B C C | N U L L |
|-------------|-------------|---|---|---|---|---|---|---|---|---|---|---|---|-------------|-------------|------------------|

| | | | | | | | | | | | | | | | | |
|----|----|----|----|----|----|----|----|----|----|----|----|----|----|----|-------------|----|
| 06 | 02 | 30 | 31 | 52 | 44 | 50 | 30 | 2D | 30 | 31 | 30 | 30 | 30 | 03 | B C C | 00 |
|----|----|----|----|----|----|----|----|----|----|----|----|----|----|----|-------------|----|

※It is responded with 1 byte sized NULL(00H) at the end of response frame (next BCC 16).

Dual PID Auto Tuning Control

• Write of setting value

In case setting value is -100

| | | | | | | | | | | | | | | |
|----|----|----|----|----|----|----|----|--------|-----------------|-----------------|-----------------|-----------------|----|---|
| A | S | 0 | 1 | W | D | S | 0 | Symbol | 10 ³ | 10 ² | 10 ¹ | 10 ⁰ | E | F |
| C | T | | | | | | | | | | | | T | S |
| K | X | | | | | | | | | | | | X | C |
| A | S | 0 | 1 | W | D | S | 0 | — | 0 | 1 | 0 | 0 | E | B |
| C | T | | | | | | | | | | | | T | C |
| K | X | | | | | | | | | | | | X | C |
| 06 | 02 | 30 | 31 | 57 | 44 | 53 | 30 | 2D | 30 | 31 | 30 | 30 | 03 | B |
| | | | | | | | | | | | | | | C |
| | | | | | | | | | | | | | | C |

• Others: In case of no response of ACK

- ① When the address is not the same after receiving STX.
- ② When receiving buffer overflow is occurred.
- ③ When the baud rate or others communication setting value are not the same.

• When there are no ACK response

- ① Check the status of lines
- ② Check the communication condition(Setting value)
- ③ When assuming the problem is due to noise, try to operate communication 3 times more until recovery.
- ④ When occurred communication failure frequently, please adjust the communicating speed.

■ Proper usage

◎ Simple "error" diagnosis

• When the load (Heater etc) is not operated

Please check operation of the OUT lamp located in front panel of the unit.

If the OUT lamp does not operate, please check the parameter of all programmed mode.

If lamp is operating, please check the output(Relay, SSR drive voltage) after separating output line from the unit.

But, the out lamp is not operated for DC4-20mA

• When it displays $\Delta P E n$ during operation

This is a warning that external sensor is open. Please turn off the power and check the wire state of the sensor. If sensor is not open disconnect sensor line from the unit and short the input +, - terminal. Turn on the power of the unit and check the controller displays room temperature.

If this unit cannot display room temperature, this unit is broken. Please remove this unit and contact our service center. (When the input mode is thermocouple, it is available to display room temperature.)

• In case of indicating $E r r D$ in display

This Error message is indicated in case of damaging inner chip program data by outer strong noise.

In this case, please send the unit to our after service center after removing the unit from system.

Noise protection is designed in this unit, but it does not stand up strong noise continuously. If bigger noise than specified(Max. 2kV) flows in the unit, it can be damaged.

◎ Caution for using

- Please use the terminal(M3.5, Max. 7.2mm) when connecting the AC power source.
- Please use separated line from high voltage line or power line in order to avoid inductive noise.
- Please install power switch or circuit-breaker in order to cut power supply off.
- The switch or circuit-breaker should be installed near by users.
- This unit is designed for temperature controlling only. Do not apply this unit as a voltage meter or a current meter.
- Be sure to use compensating wire when extending wire from controller to thermocouple, otherwise a temperature deviation will occur at the point where wires are connected to each other.
- In case of using RTD sensor, 3-wire type must be used. If you need to extend the line, 3-wires must be used with the same thickness as the line. It might cause temperature difference if the resistance of line is different.
- In case of making power line and input signal line close, line filter for noise protection should be installed at power line and input signal line should be shielded.
- Keep away from the high frequency instruments.(High frequency welding machine & sewing machine, big capacitive SCR controller)
- If you want to change the input sensor, reset switches (SW1, SW2) according to each input specification after power off. Turn on power and then set sensor mode by front keys at second flow chart.
- This SSR and current of this controller are insulate from internal power.
- Do not connect power line to sensor connecting part. The inner circuit may be damaged.
- Installation environment
 - It shall be used indoor.
 - Altitude Max. 2000m.
 - Pollution Degree 2
 - Installation Category II.

(A) Photo electric sensor

(B) Fiber optic sensor

(C) Door/Area sensor

(D) Proximity sensor

(E) Pressure sensor

(F) Rotary encoder

(G) Connector/Socket

(H) Temp. controller

(I) SSR/Power controller

(J) Counter

(K) Timer

(L) Panel meter

(M) Tacho/Speed/ Pulse meter

(N) Display unit

(O) Sensor controller

(P) Switching mode power supply

(Q) Stepper motor& Driver&Controller

(R) Graphic/Logic panel

(S) Field network device

(T) Software

(U) Other